



[QK30 Series] 2-D Presentation Scanner

The QK30 scanner is specifically designed to read 1-D and 2-D barcodes displayed on cell phone screens and printed on paper. The QK30 is the only scanner in its class to offer programmable multicolored LEDs and play audio files. The compact device is 50 percent thinner than previous models, yet has a 30 percent larger scanning area. Applications include e-tickets, e-coupons and e-membership cards.

INDUSTRY'S MOST ADVANCED



Optimized performance for both mobile and printed codes

Enables high-speed scanning of 1-D and 2-D Codes displayed on LCD screens. Excellent scanning performance for codes printed on paper, too.

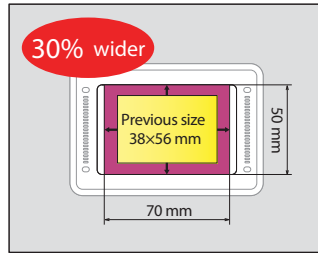

* When scanning codes displayed on an LCD screen

Can scan codes displayed on large-screen smartphones

Scanning area 30% larger than previous model, enabling easier scanning.

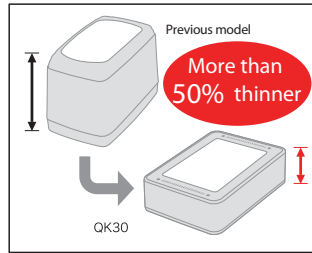

Compact, Stylish Design

More than 50% thinner than previous model, increasing placement flexibility.

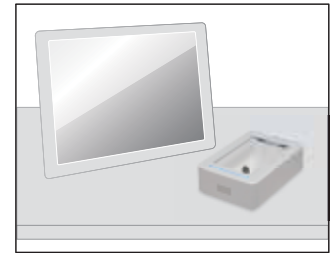

Advanced Features

- ▣ Plays audio files
- ▣ Programmable multicolored LEDs
- ▣ Remote management

2-D PRESENTATION SCANNER

- ▣ Scans smartphone displays
- ▣ Scans both mobile and printed QR Codes® and barcodes



Countertop model QK30-U
 In-counter model QK31-U
 In-counter model QK31-R

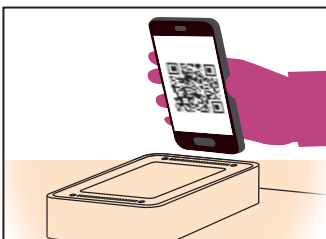

Mobile coupon



Mobile membership card

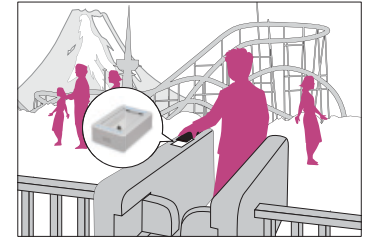

Mobile ticket

Wide range of applications includes use with point-of-sale terminals and incorporation into kiosks and entrance gates.

Makes it easy for customers to use mobile coupons, mobile memberships and mobile tickets.

TECHNICAL DATA

Type		Countertop		In-Counter	
Model Name		QK30-U		QK31-U	
Scanner	Readable codes	2-D code	QR Code, micro QR Code, SQRC®, iQR Code, PDF417, micro PDF, Data Matrix, Aztec, GS1 DataBar Composite (EAN.UCC Composite), MaxiCode		
		Barcode	EAN-13/8 (JAN-13/8), UPC-A/E, UPC/EAN (with add-on), Interleaved 2 of 5 (ITF), Standard 2 of 5 (STF), Codabar (NW-7), Code 39, Code 93, Code 128, GS1-128 (EAN-128), GS1 DataBar (RSS)		
	Minimum resolution	2-D code	0.25 mm		
		Barcode	0.18 mm		
	Scanning area	70 mm × 50 mm			
	Focusing point	7 mm ¹			
	Scan confirmation	LED (blue/red/green), audio		—	
Communication Interface	Method	USB 1.1-compliant (COM, HID) ²		RS-232C	
	Connector	USB connector: type A (integrated cable)	USB connector: type B (detachable cable)	Mini-DIN connector (with detachable cable)	
	Cable length	1.5 m	1.4 m (sold separately)	1.5 m (sold separately)	
Power	Power	Supply from host device ³			
Environmental requirements	Protection level	IPX2		—	
	Operating temperature	23 to 122 °F (-5 to 50 °C)			
	Operating humidity	10-90% RH (non-condensing/non-freezing)			
Weight	250 g (incl. cable weight)		170 g (excl. cable weight)		

1: Height from dustproof plate

2: Two interfaces are supported: USB keyboard and USB-COM. When using USB-COM mode, download USB driver from DENSO ADC website.



3: Connection may not be possible depending on model of PC or USB hub.

PRODUCT CONFIGURATION

Accessories

- Scanner
- Operation guide
- Instruction manual 

Software

- Driver 
- Driver (active USB-COM port)
- Setting software (2-D scanner setting) 

Options

- USB cable for QK31-U (1.4 m)
 - RS-232C cable for QK31-R (1.5 m)
-  Items with this symbol are available from www.denso-adc.com free of charge.

DIMENSIONS

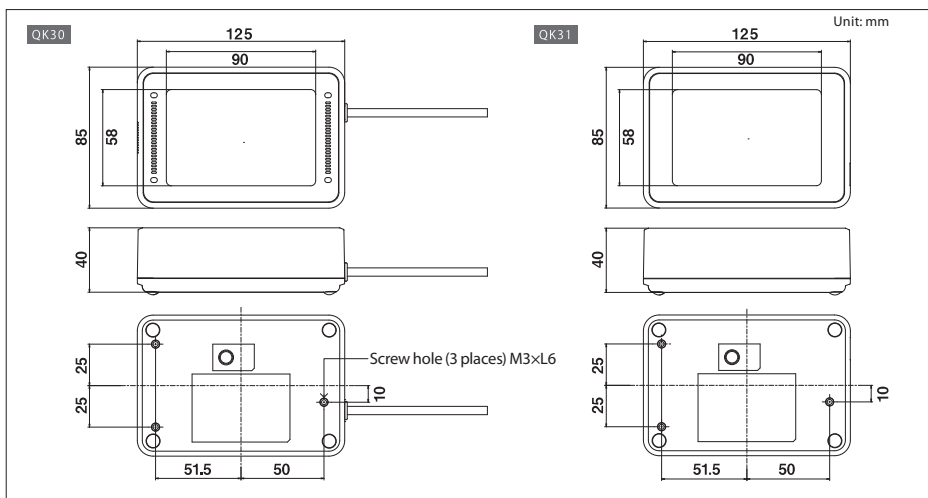

To use this product safely
Before using this product, please read its User's Manual thoroughly.



QK30 Web page

[DENSO ADC]

3900 Via Oro Ave.
Long Beach, CA. 90810
Phone + (888) MY DENSO
+ (888) 693 3676
Fax + (310) 835 8724
denso-adc@densodrive.com
www.denso-adc.com

Legacy Technology Services

We Rent & Sell All Types Of Barcode Equipment

Call now to talk to an expert

866-271-9891

www.LegacyGlobal.com

Some brands we carry



MOTOROLA

Intermec

DATALOGIC™

Honeywell

EQUINOX
PAYMENTS



About us

- Legacy Technology Services is a leading nationwide provider of mobile computing, barcode, printers and point of sale equipment and services.
- For over a decade, thousands of clients across North America have trusted us to provide equipment from leading manufacturers backed by the services to support them.

Latest Hardware from top manufacturers

- Legacy handles virtually every major manufacturer of mobile computing, barcoding and point of sale equipment.

Expert Repair and Maintenance services

- Legacy is one of the best repair facilities in North America

Discontinued product sourcing

- They don't make it anymore? Our inventory also includes manufacturer close-outs and discontinued equipment to support our clients legacy infrastructure.

Trade-in and Disposal services

- That old equipment laying around your facility may still have some value. Legacy routinely purchases equipment from our clients around the globe.
 - Data destruction
 - Hardware disposal
 - Auditing services

Dedicated client account team

- Dedicated, highly trained account managers are here to answer all your questions and provide top notch service.

Equipment rental services

- Sometimes renting is a better solution, Legacy's huge rental inventory provides the equipment you need for temporary needs and projects.



Legacy, Inc.

160 West Road,
Ellington, CT 06029

Toll Free: 866-271-9891

Fax: 888-522-4684